



ARCHITECTURAL INSULATED WALL PANEL

Freeman Group panels are manufactured and tested to BS EN 14509 standards from the highest quality materials, using state of the art production equipment to rigorous quality control standards, ensuring long term reliability and service life.



PANEL MANUFACTURING

QUALITY AND DURABILITY

Freeman Group panels are manufactured and tested to BS EN 14509 standards from the highest quality materials, using state of the art production equipment to rigorous quality control standards, ensuring long term reliability and service life.

WARRANTY

In business, your reputation is everything and minimising risk makes sound business sense. Freeman Group's range for thermal insulated cladding will

give you the peace of mind you've chosen a quality material that conforms to relevant Australian and New Zealand standards and backed by a warranty you can count on.

PACKAGING AND DELIVERY

Protective film is applied to the steel facing during the production process. Freeman Group insulated panels are stacked flat. The number of panels in each pack depends on panel thickness. Handling guidelines are available from Freeman Group Technical Services.



PANEL OVERVIEW

WHY PIR CORE?

Economic Advantages

Accelerated construction reduces site time and energy efficiency of PIR core, which can reduce operating costs by up to 50%.

Insulation Properties

Due to the low heat conductivity of its fully formed closed cell structure, PIR is thermally efficient. This superb thermal performance allows buildings to achieve premium levels of energy efficiency, with some of the thinnest available solutions.







Durability

As PIR does not sag or absorb moisture you can be confident of consistent performance which will last the full lifetime of the building.

Fire Resistance

PIR will self-extinguish as soon as the cause of fire is removed. PIR foam is a thermosetting material. It does not melt, flow or drip when exposed to fire and it will form a strong char that helps protect the foam core and prevent flame spread within the panels.

Occupant advantages

-  Passive temperature control for a more stable environment.
-  Superior water, condensation and moisture proofing.
-  Low allergenic qualities.
-  Superior seismic performance.
-  High fire rating for maximum inhabitant safety.
-  Paint and steel finish option.
-  Lifetime performance, with no deterioration of airtightness or insulation values.

Moisture Resistance

Water absorption through exposure to moisture or in exceptional circumstances through floods, is a significant factor with any modern insulation product. Due to having a closed cell structure, PIR is a hydrophobic product, meaning it does not absorb water. This allows the thermal performance and integrity of the product to be retained regardless of water exposure.

STEEL FACING

Colours

Our standard colour is Titania. Other colours are available on request. However, please note that the colour chart shown here is indicative only and is as close as the printing process allows. If in doubt before ordering, please refer to your Freeman Group agent's colour chart.



Zincalume® coating

The Zinc/Aluminium alloy coated steel has been formulated to give a significantly longer service life than a galvanized coating. This is of particular value in New Zealand where the prevailing winds carry corrosive salt-laden air many kilometers inland.



FREEMAN GROUP ARCHITECTURAL INSULATED WALL PANEL

PRODUCT INFORMATION

Freeman Group architectural insulated wall panels are designed to be used for an external facade element and can be installed horizontally or vertically. They are suitable across a broad range of applications and environments adding strength, thermal and fire performance, as well as texture and depth to the building envelope.

Panel Performance

Thickness (mm)	50	75	100
R Value at 15°C (mK/W)	2.4	3.7	4.9
R Value at 23°C (mK/W)	2.3	3.5	4.7
Weight (Kg/m ²)	10.8	11.8	12.8
Unsupported Span (m)	3.0	4.3	5.0

Weight for 0.5/0.5 facings

Acoustic Properties

Freq	125	250	500	1000	2000	4000	STC	RW
Hz	16.1	17.5	19.2	23	32.2	36.8	20	23

Tested to ISO 10140-2 on 75mm panel

Fire Performance

AS 1530.3 - Group 1-S	
Ignitability Index	0
Spread of Flame Index	0
Heat Evolved Index	0
Smoke Index	1
Fire Resistance Test: AS 1530.4	--/120/30

Foam Plastic Core	
Core meets the requirements of AS1366.2	

External Radiation(ISO 5660-1:2015)	
Total Heat THRR	Peak Heat PHRR
34.7 MJ/m ²	83.5 kW/m ²

Product Properties

Core	Fire-retardant (PIR) foam
External facing	0.55mm thick Zinc/Aluminium G300S AZ150 coated steel to AS 1397
Internal facing	0.55mm thick Zinc/Aluminium G300S AZ150 coated steel to AS 1397
Width	1000mm cover width
Length	As required, 2m - 24m
Thickness	50mm, 75mm, 100mm

Other steel thicknesses and coatings upon request.

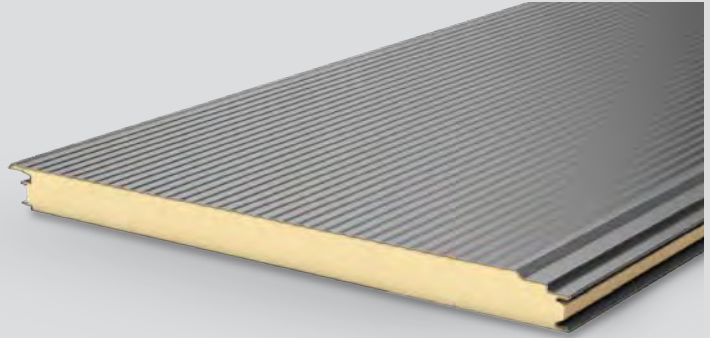

PROFILE OPTIONS

Wave - Triple Rib



Wave - Single Rib

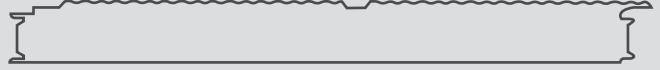

Wave



S Line

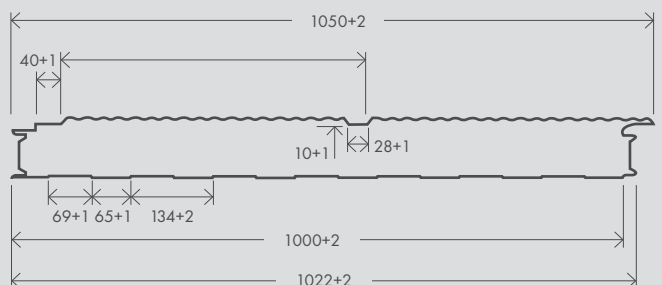
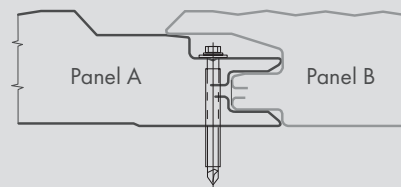

WD01 HORIZONTAL WALL BASE ON SLAB

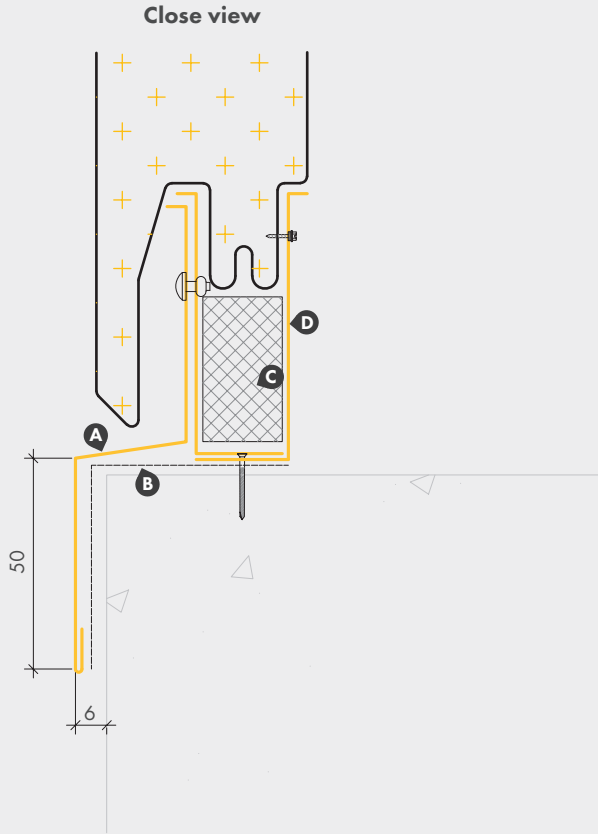

- A** Freeman Group COLORSTEEL® Cover Flashing
- B** DPC to face of bottom plate and floor overlap
- C** Fill gaps with FR foam filler
- D** Freeman Group COLORSTEEL® Base flashing

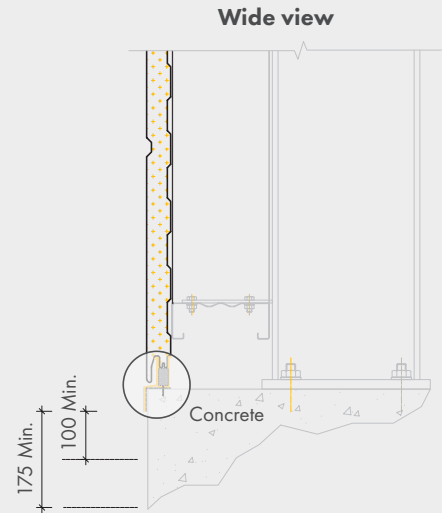

WD02 HORIZONTAL WALL BASE ON REBATED SLAB

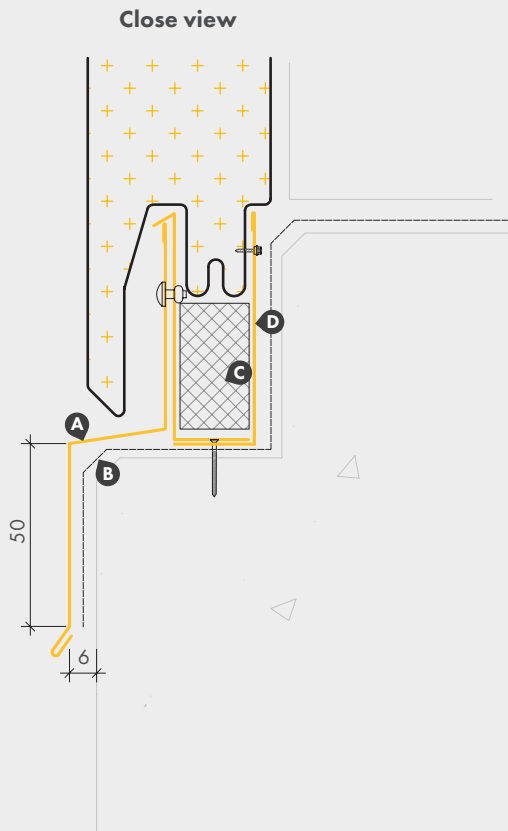

- A** Freeman Group COLORSTEEL® Cover Flashing
- B** DPC to face of bottom plate and floor overlap
- C** Fill gaps with FR foam filler
- D** Freeman Group COLORSTEEL® Base flashing

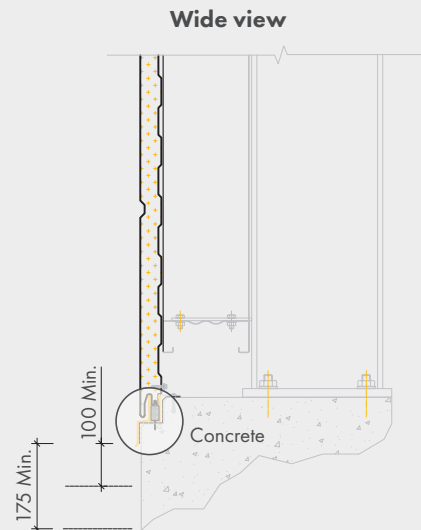



WD03 HORIZONTAL PANEL EXTERNAL MOUNT BASE BRACKET

Wide view

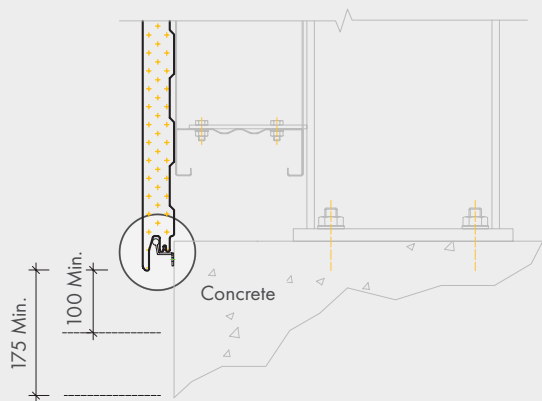

Close view

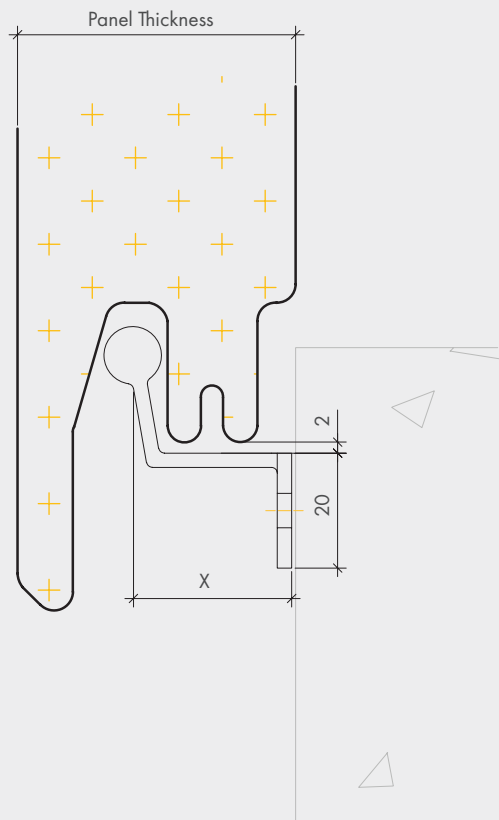

- A** Weld 25 stitch 4mm fillet with 40mm spacing typical
- B** Weld 25 stitch 4mm fillet with 40mm spacing typical

Panel Thickness	Dimension X
50mm	28mm
75mm	52mm
100mm	79mm

Note:

Panel bearer fixing centres 1500mm Maximum.

Material 2.5mm thick mild steel.

Finish BNZ and clear, BS 1796 1990 Ff ZN 51A or hit dip galvanized.

Bracket detail top view

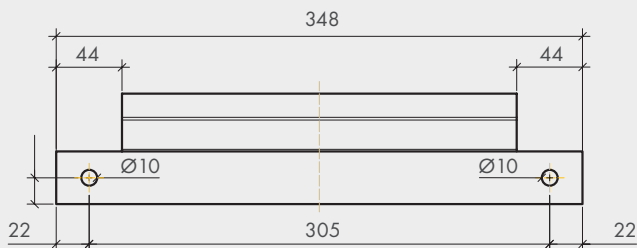

Bracket detail front view

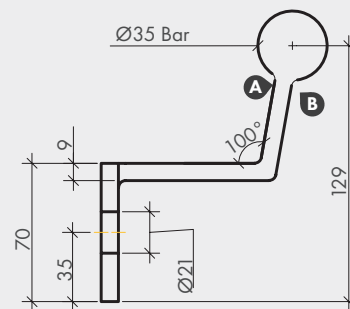

WD04 HORIZONTAL PANEL - EXTERNAL CORNER DETAIL

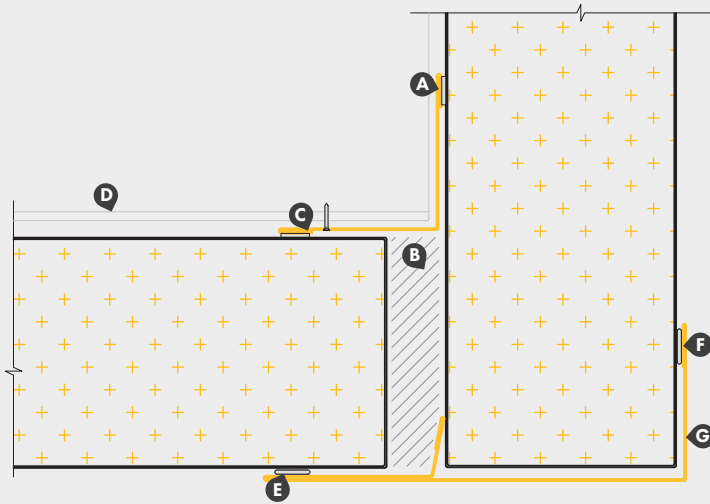

- A** Lap seal tape
- B** Profiled filler sealed top and bottom
- C** Freeman Group COLORSTEEL® Soaker flashing
- D** Purlin
- E** Holdfast fixall 220 LM MS
- F** Holdfast fixall 220 LM MS
- G** Freeman Group COLORSTEEL® Cover flashing

WD05 HORIZONTAL PANEL - TILT SLAB PANEL JUNCTION DETAIL

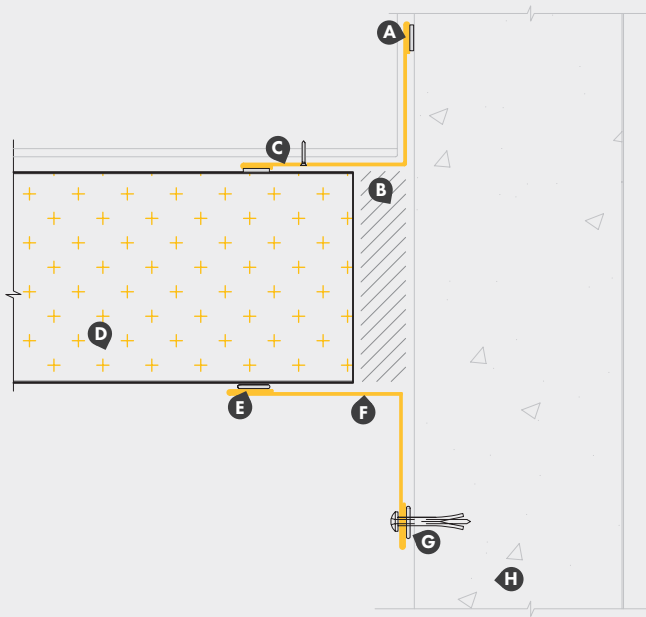

- A** Holdfast fixall 220 LM MS
- B** Profiled filler sealed top and bottom
- C** Freeman Group COLORSTEEL® Soaker flashing
- D** Freeman Group wall panel
- E** Holdfast fixall 220 LM MS
- F** Freeman Group COLORSTEEL® Cover flashing
- G** Holdfast fixall 220 LM MS
- H** Tilt slab panel

WD06 VERTICAL PANEL - TILT SLAB PANEL JUNCTION DETAIL

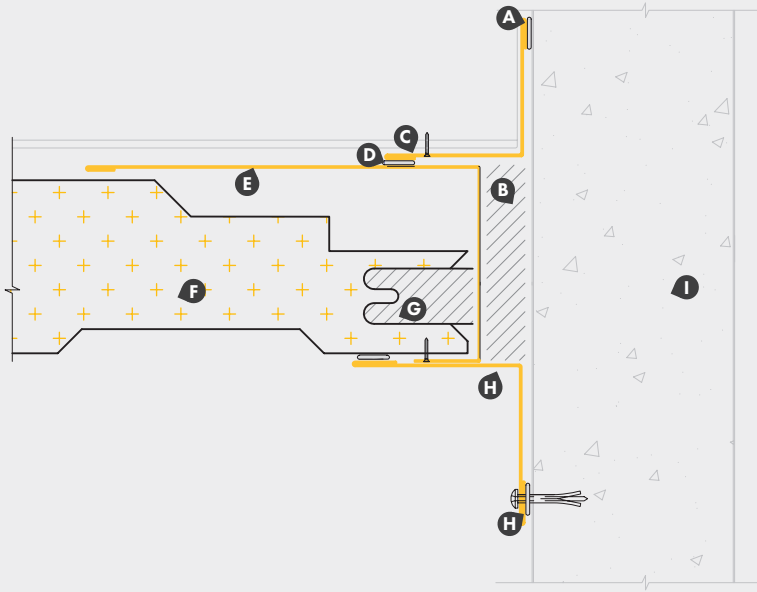

- A** Holdfast fixall 220 LM MS
- B** Profiled filler sealed top and bottom
- C** Freeman Group COLORSTEEL® Soaker flashing
- D** Holdfast fixall 220 LM MS
- E** Freeman Group COLORSTEEL® Cap flashing
- F** Freeman Group wall panel
- G** Foam
- H** Freeman Group COLORSTEEL® Cover flashing
- I** Tilt slab panel

WD07 HORIZONTAL PANEL - RESIDENTIAL WINDOW HEAD DETAIL COLUMN

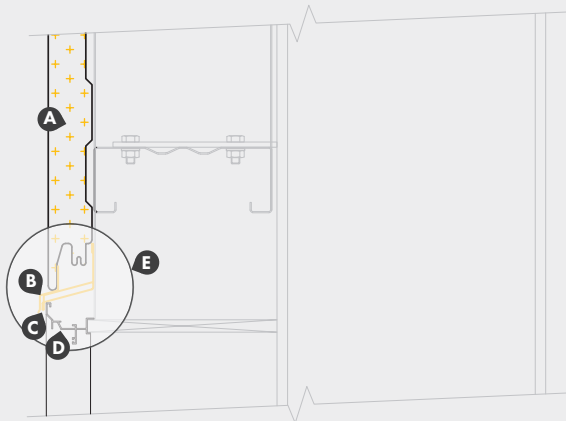

- A** Freeman Group wall panel
- B** Freeman Group COLORSTEEL® Rainscreen flashing
- C** Freeman Group COLORSTEEL® Head flashing with 15° fall
- D** Window joinery
- E1** Freeman Group COLORSTEEL® Rainscreen flashing
- E2** Freeman Group COLORSTEEL® Head flashing with 15° fall

E Detail

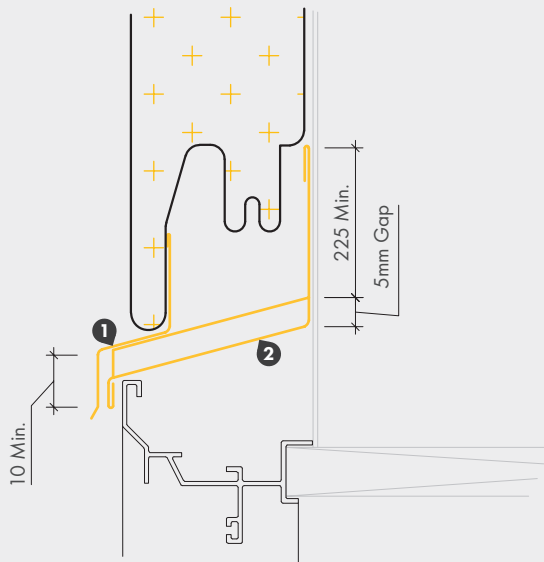

WD08 HORIZONTAL PANEL - RESIDENTIAL WINDOW JAMB DETAIL

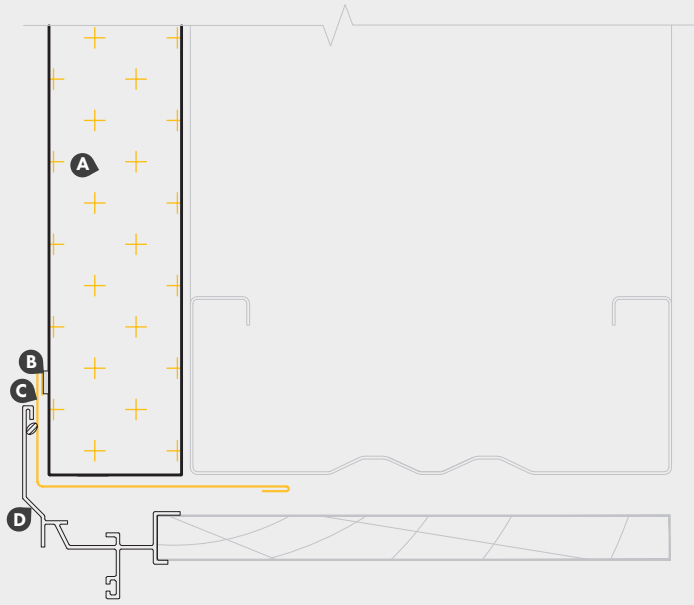

- A** Freeman Group wall panel
- B** Trimseal lap tap
- C** Freeman Group COLORSTEEL® Jamb flashing
- D** Window joinery

WD09 HORIZONTAL PANEL - RESIDENTIAL WINDOW SILL DETAIL

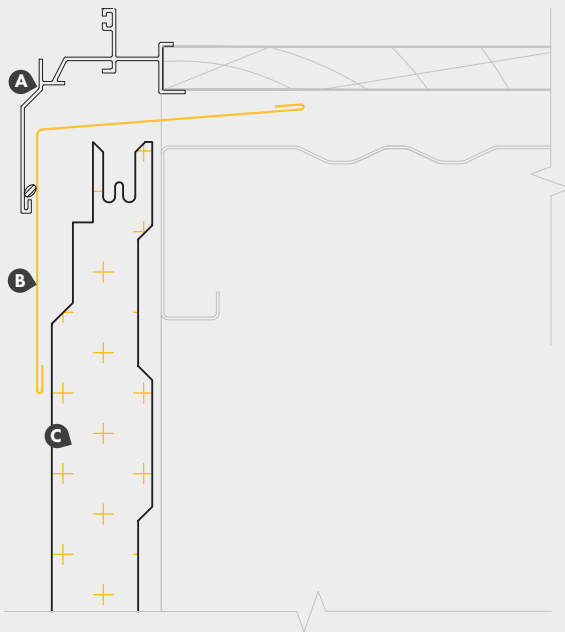

- A** Window joinery
- B** Freeman Group COLORSTEEL® Sill flashing
- C** Freeman Group wall panel

WD10 HORIZONTAL PANEL - COMMERCIAL JOINERY HEAD DETAIL

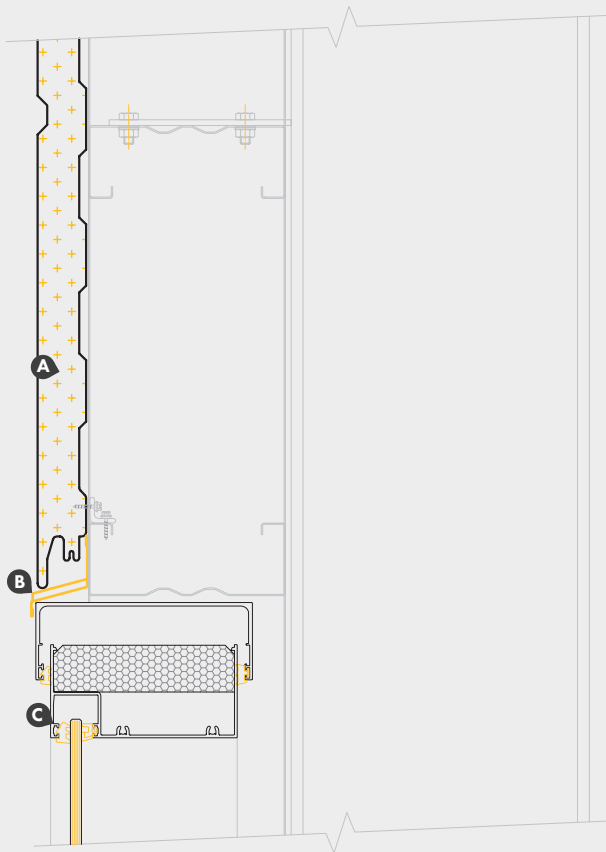

- A** Freeman Group wall panel
- B** Freeman Group COLORSTEEL® Head flashing with 15° fall
- C** Window joinery

WD11 HORIZONTAL PANEL - COMMERCIAL JOINERY JAMB DETAIL

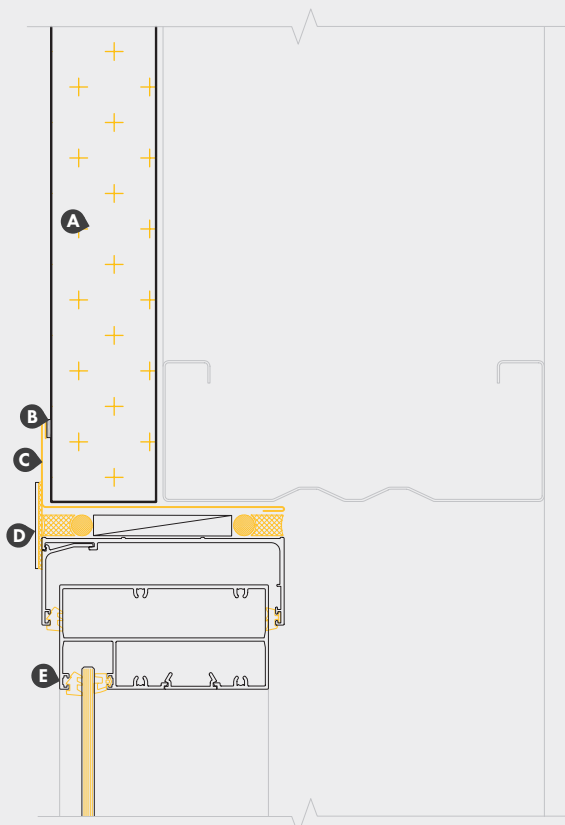

- A** Freeman Group wall panel
- B** Trimseal lap tape
- C** Freeman Group COLORSTEEL® Jamb flashing
- D** Cover strip
- E** Window joinery

WD12 HORIZONTAL PANEL - COMMERCIAL JOINERY SILL DETAIL

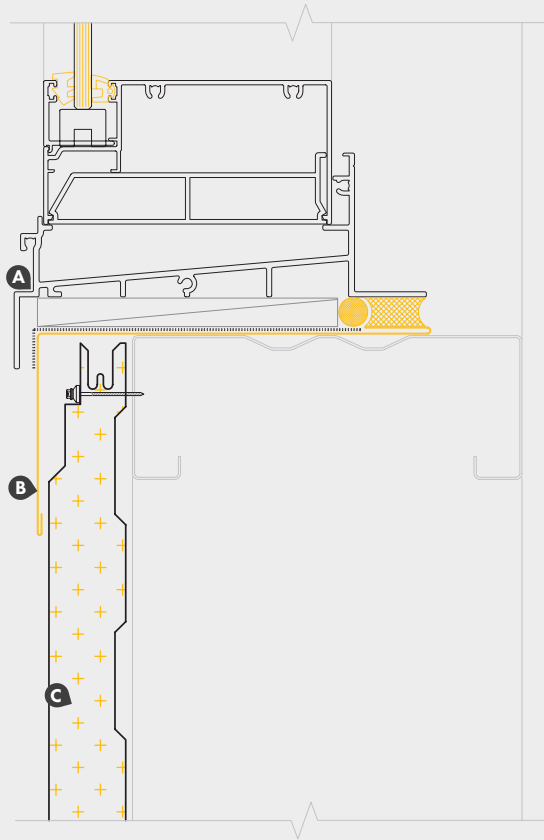

- A** Window joinery
- B** Freeman Group COLORSTEEL® Sill flashing
- C** Freeman Group wall panel

WD13 HORIZONTAL PANEL - WALL PENETRATION DETAIL

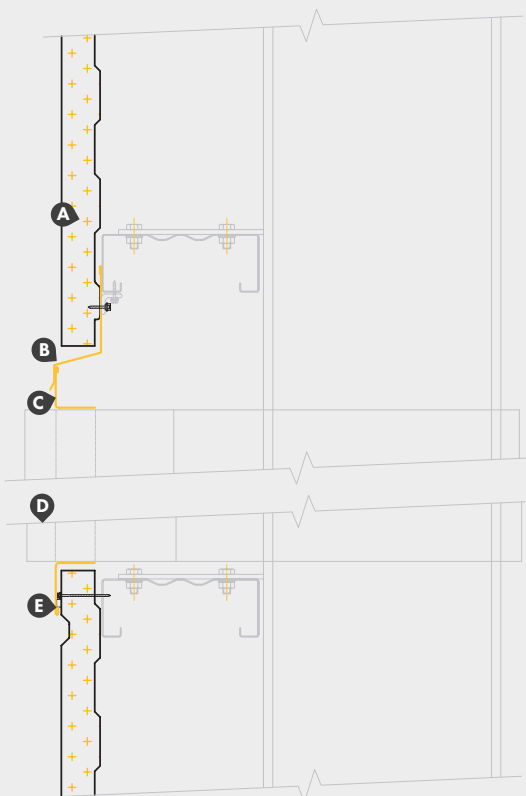

- A** Freeman Group wall panel
- B** Freeman Group COLORSTEEL® Head flashing
- C** Freeman Group COLORSTEEL® Angle flashing sealed and riveted to penetration and head flashing
- D** Wall penetration
- E** Continuous compressible foam strip seal

WD14 EAVE DETAIL

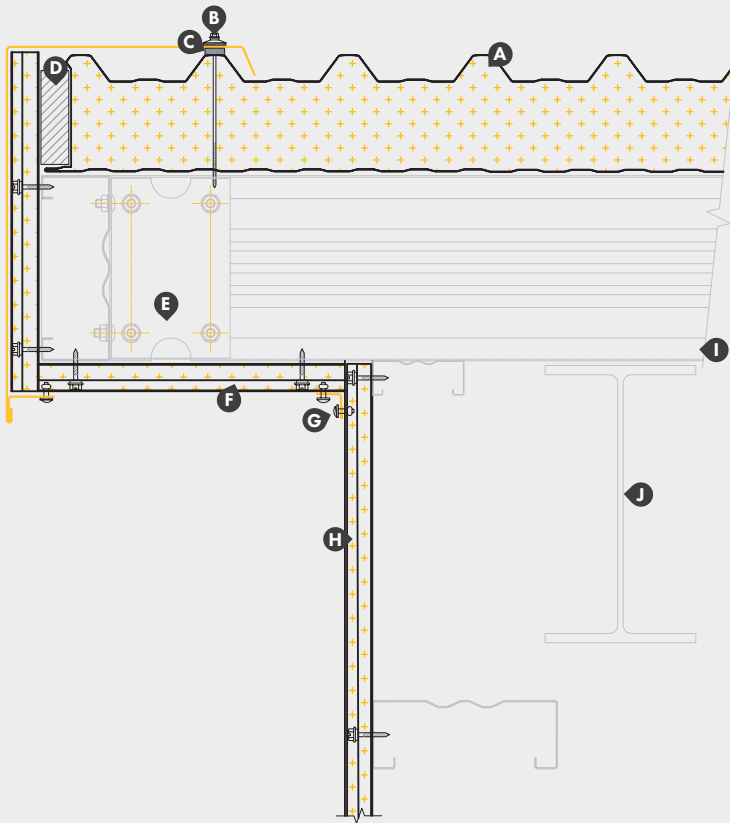

- A** Freeman Group roof panel
- B** 26mm Embossed washer
- C** Trimseal lap tape
- D** Fill gaps with FR foam filler
- E** GP Bracket
- F** Freeman Group wall panel
- G** 4mm Blind rivet
- H** Freeman Group COLORSTEEL® Sill flashing
- I** Purlin
- J** Portal rafter beam

WD15 PARAPET DETAIL

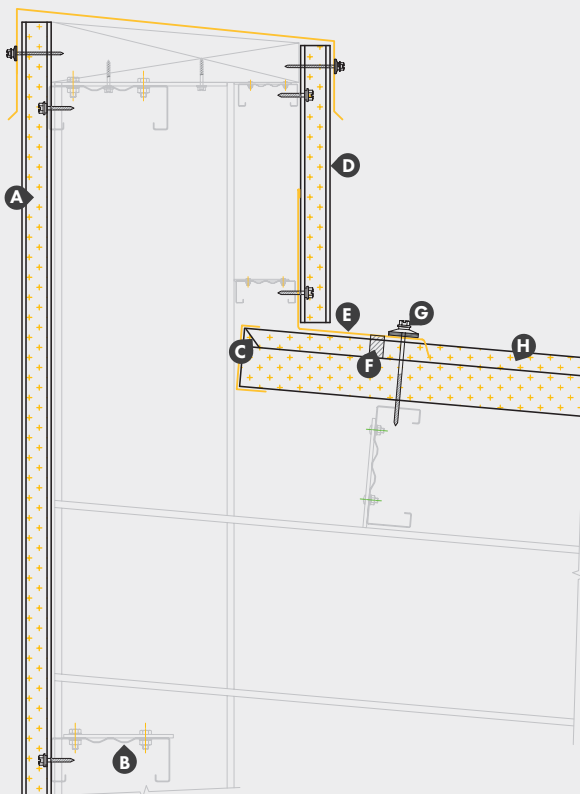

- A** Freeman Group wall cladding panel
- B** Purlin
- C** Turn up panel end
- D** Freeman Group wall cladding panel
- E** Freeman Group COLORSTEEL® Apron flashing
- F** Fill gaps with FR foam filler
- G** 25mm Embossed washer
- H** Freeman Group roof panel



www.freemanroofing.co.nz

Family owned since 1956

